



# SOSEN LED Driver, Your Smart Choice

## Specifications

### SS-35VA-L50B LED Driver

Model: SS-35VA-L50B

Description: 35W LED Driver

Rev.: V05

Release Date: 2023-02-01

# SS-35VA-L50B LED Driver

**SOSEN**  
LED DRIVER



**LED DRIVER**

**VA-L Series**

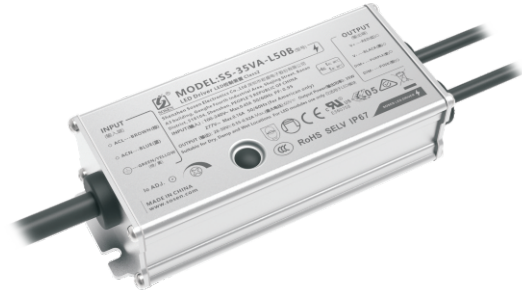

## Features:

- Efficiency up to 89%
- Isolated dimming:0-10V,PWM,Resistor
- Surge protection: CM: 10kV, DM: 6kV
- Standby Power<1W
- IP67
- Protections: SCP/OVP
- Warranty: 5 years



## Description :

SS-35VA-L50B is 35W constant current LED Driver with 90-305Vac input. It has high efficiency, high PF, high reliability, compact housing, good cooling, all-around protections. LED luminaries manufactures can easily design luminaries and reduce cost.

### Applications:

Stadium lighting, Plant lighting, Tunnel lighting, Stage lighting

## Model List:

Model	AC Input Range	Max. Pout	Vout Range	Full Power Vo Range	Iout	Default Current	THD(Typ.)	PF(Typ.)	Eff.(Typ.)	Max.Tc
SS-35VA-L50B	90-305Vac	35W	28-50V	38-50V	0.55-0.92A	0.72A	12%	0.97	89.0%	90°C

Note:

- 1.Default Tested: at 220Vac, full load, Ta 25°C.
- 2.The performance of the LED Driver can be guaranteed within the full power Vo range.The voltage lower than full power Vo range, it is need to test the performance with the LED module;

# SS-35VA-L50B LED Driver

## Input Characteristics:

Parameter	Min.	Typ.	Max.	Remark
Rated AC Input Range	100Vac		277Vac	
AC Input Range	90Vac		305Vac	Input<100Vac , 90% load , Reference derating curve
Input Frequency Range	47Hz	50/60Hz	63Hz	
Max Input Current			0.45A	100Vac, Full load
			0.16A	277Vac, Full load
Max Input Power			45W	100Vac, Full load
Max Inrush Current(120Vac)			35A	Cold start
Max Inrush Current(220Vac)			45A	Cold start
Max Inrush Current(277Vac)			70A	Cold start
Standby Power			1W	220Vac/50Hz, Dim to off
Power Factor	0.95	0.97		220Vac/50Hz, Full load
	0.90			100-277Vac/50Hz, 70-100% load
THD		12%	15%	220Vac/50Hz, Full load
			20%	100-277Vac/50Hz, 70-100% load

# SS-35VA-L50B LED Driver

## O/P Characteristics:

Parameter	Min.	Typ.	Max.	Remark
O/P Voltage Range	28V		50V	Power derated @28-38V
Rated O/P Voltage	38V		50V	$P_o = V_o \cdot I_o = 35W$ , Full load
Rated O/P Current	0.7A		0.92A	0.92A for 38V, 0.7A for 50V
Adj. O/P Current (AOC) Range	0.55A		0.92A	
No Load Voltage			60V	
Efficiency @120Vac	85.0%	87.0%		O/P 50V/0.7A
Efficiency @220Vac	86.0%	89.0%		O/P 50V/0.7A
Efficiency @277Vac	86.0%	88.0%		O/P 50V/0.7A
O/P Current Tolerance	-7%		+7%	
O/P Current Ripple(PK-AV)		85%	100%	Full load
Start-up Current Overshoot			10%	Full load
Start-up Time			1.0S	120Vac, Full load
			0.5S	220Vac, Full load
Line Regulation	-7%		+7%	Full load
Load Regulation	-7%		+7%	
Temperature Coefficient	-0.07%/°C		+0.07%/°C	Tc: 0°C~90°C
Short Circuit Protection			5W	Driver will not be damaged, Hiccup mode

# SS-35VA-L50B LED Driver

## Other Characteristics:

Parameter		Min.	Typ.	Max.	Remark
0-10V Dimming (Optional)	Dim Vmax	0V		12V	DIM+ source current 110uA.
	Dim Range	10%Iomax		100%Ioset	Dimming prohibits reverse connection
	Rec.Dim Range	0V		10V	
5-0V Dimming (Optional)	Dim Vmax	0V		5V	DIM+ source current <300uA.
	Dim Range	100%Iomax		10%Ioset	Dimming prohibits reverse connection
	Rec.Dim Range	0V		5V	
10-0V Dimming (Optional)	Dim Vmax	0V		10V	DIM+ source current <300uA.
	Dim Range	100%Iomax		10%Ioset	Dimming prohibits reverse connection
	Rec.Dim Range	0V		10V	
PWM Dimming (Optional)	PWM High	9.8V		10.2V	DIM+ source current 110uA.
	PWM Low	0V		0.3V	Dimming prohibits reverse connection
	Frequency	1KHz		2KHz	
	PWM Duty	0%		100%	
Resistor Dimming (Optional)	Resistance	0Kohm		100Kohm	DIM+ source current 110uA.
	Dim Range	10%Iomax		100%Ioset	
Dim to Off	Dim off	3%	5%	7%	If the led is less than 42V,the luminaries may possibly have slight light when dim-to-off. Thus the whole lighting system needs to be tested
	Dim on	5%	7%	9%	
Dim to Off(5-0V)	Dim off	4.7V	4.85V	5V	
	Dim on	4.6V	4.75	4.9V	
Lifetime(Tc≤80°C)		≥62,000 hours			80% load
MTBF		262,000 hours			220Vac,Full load, Ta=25°C (MIL-HDBK-217F)
IP Grade		IP67			
Tc		90°C			
Warranty		5 years			Tc : 80°C
Net Weight		330g			
Dimension		120mm*50mm*31mm			L x W x H

NOTE: All the parameters above are tested Ta 25°C and LED load, unless specified.

# SS-35VA-L50B LED Driver

## Environmental Requirements

Parameter	Min.	Typ.	Max.	Remark
Operating Temperature(Tcase)	-40°C	25°C	+90°C	
Storage Temperature	-40°C	25°C	+90°C	
Operation Humidity	10%RH		90%RH	
Storage Humidity	5%RH		95%RH	
Altitude	-65m		4000m	

## Safety and EMI/EMS Standards

Certification	Standard	Status	Remark
UL/cUL	UL8750	✓	
ENEC	EN 61347-1:2015 EN 61347-2-13:2014 EN 61347-2-13:2014/A1:2017	✓	
RCM	AS/NZS61347.2.13	✓	
CCC	GB 19510.14-2009	✓	
CE	EN 61347-2-13:2014 EN61347-1:2008+A1:2011+A2:2013	✓	

EMI/EMS	Criterion	Remark
Conduction Emission	EN55015:2013+A1:2015 FCC Part 15 Subpart B; ANSI C63.4:2014	Class B
Radiation Emission	EN55015:2013+A1:2015 FCC Part 15 Subpart B; ANSI C63.4:2014	Class B
Harmonic Current Emissions	IEC/EN 61000-3-2	Class C
Surge	IEC/EN61000-4-5	DM: 6kV,CM: 10kV,Criterion B
	ANSI/C82.77-5-2017	DM: 6kV,CM: 6kV,Criterion B
Ring Wave	IEC/EN 61000-4-12	DM: 6kV,CM: 6kV,Criterion B

# SS-35VA-L50B LED Driver

## Safety Test Items:

Safety Test Items	Technical Indicators			Remark
	UL Insulation Requirements	ENEC Insulation Requirements	CCC Insulation Requirements	
Insulation Requirements	UL Insulation Requirements	ENEC Insulation Requirements	CCC Insulation Requirements	
Input-O/P	1600Vac	3000Vac	3750Vac	Reinforced insulation
Input-Case	1600Vac	1500Vac	1875Vac	Basic insulation
Input-Dim	1600Vac	3000Vac	3750Vac	Reinforced insulation
O/P-Dim	1600Vac	1000Vac	1000Vac	Basic insulation
O/P-Case	500Vac	1000Vac	1000Vac	Basic insulation
Dim-Case	500Vac	250Vac	250Vac	Basic insulation
Insulation Resistance	≥10MΩ			Input-O/P,Test voltage:500Vdc
Ground Resistance	≤0.1Ω			25A/1min
Leakage Current	≤0.75mA			277Vac

### NOTE:

1. SOSEN warrants the LED Driver itself complies with EMC standard. However, LED Driver's EMC should be re-checked when integrated into lighting systems due to unexpected interference of components.
2. Please short (ACL and ACN), (V+ and V-), (Dim+ and Dim -) when Hi-pot test.
3. The CCC withstand voltage test needs to disconnect the built-in lightning protection tube. According to the IEC 60598-1:14 standard section 10.2, the "built-in lightning protection tube" can be marked on the nameplate to disconnect the discharge tube on testing.

## Performance Curves:

### Input Inrush Current

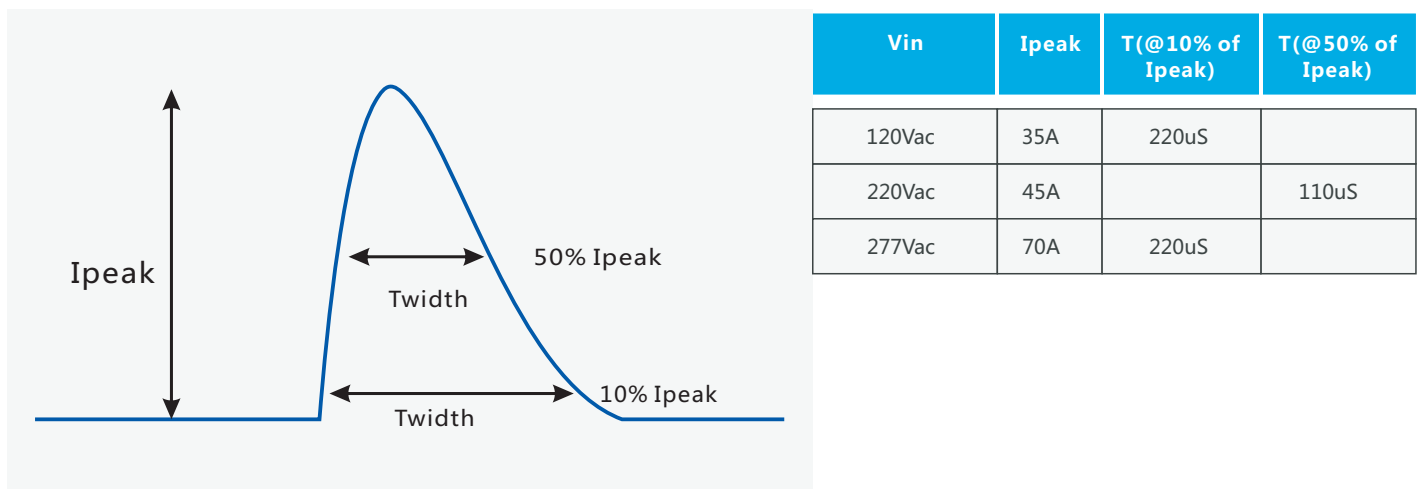

# SS-35VA-L50B LED Driver

## Performance Curves:

O/P Voltage Vs. O/P Current(Dim/AOC Window)

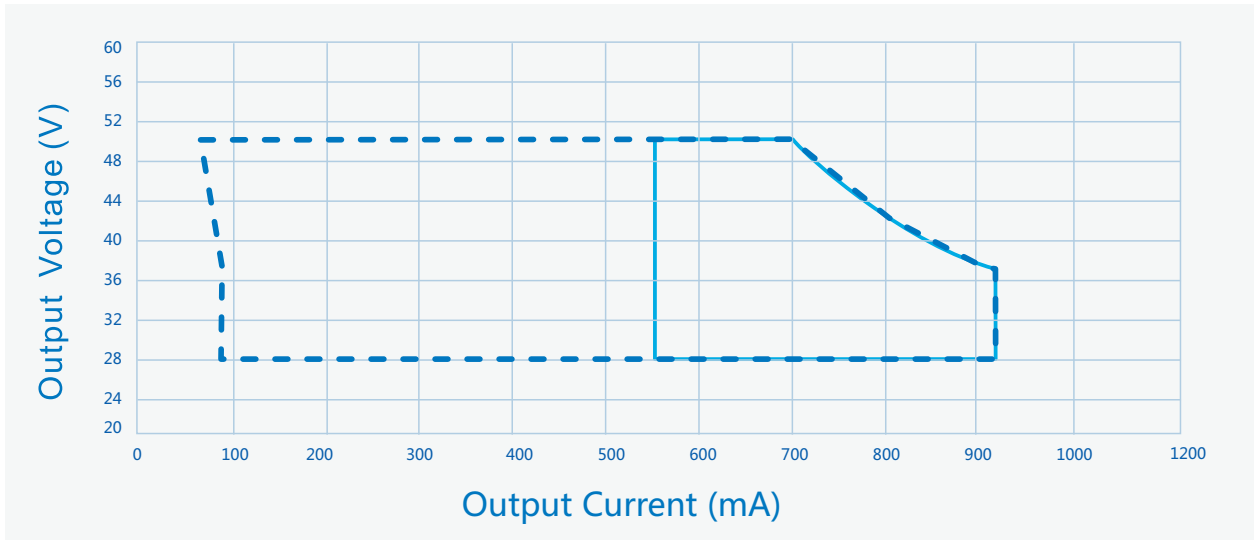

----- Dimming Window      ————— AOC Window

Efficiency Vs. O/P Voltage ( $V_{in}=120Vac$ )

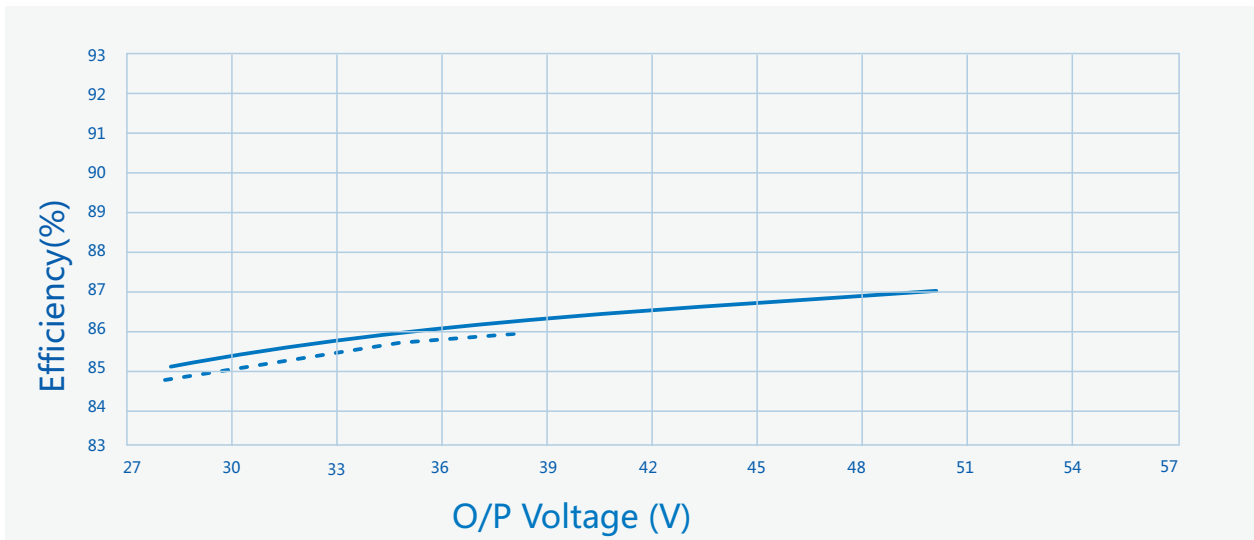

-----  $I_o=920mA$       —————  $I_o=700mA$



# SS-35VA-L50B LED Driver

## Performance Curves:

Efficiency Vs. O/P Voltage ( $V_{in}=220V_{ac}$ )

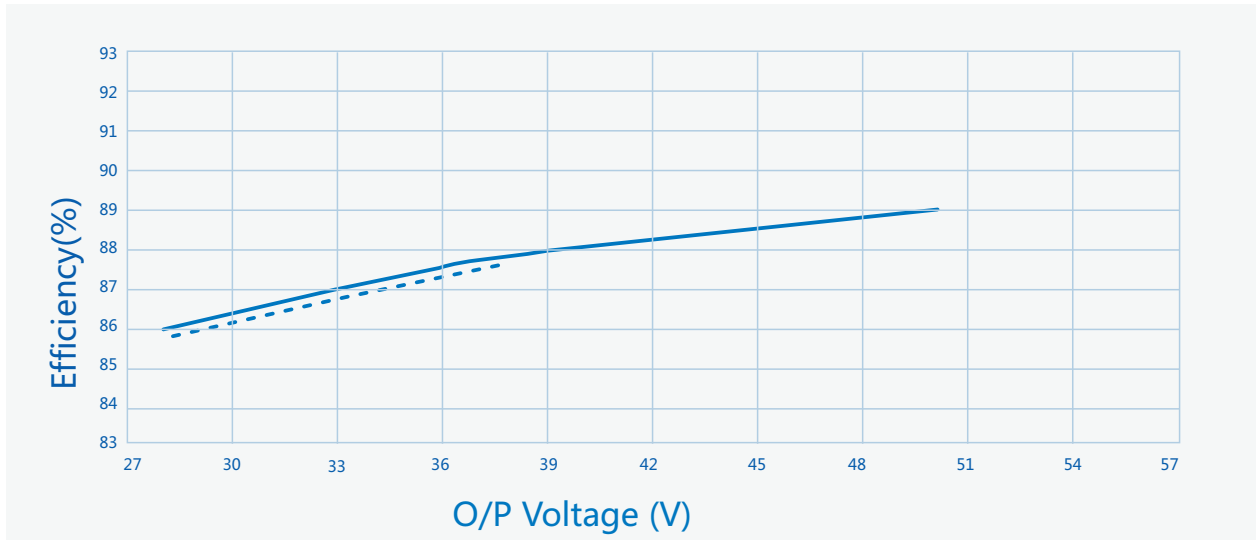

-----  $I_o=920mA$       —————  $I_o=700mA$

Efficiency Vs. O/P Voltage ( $V_{in}=277V_{ac}$ )

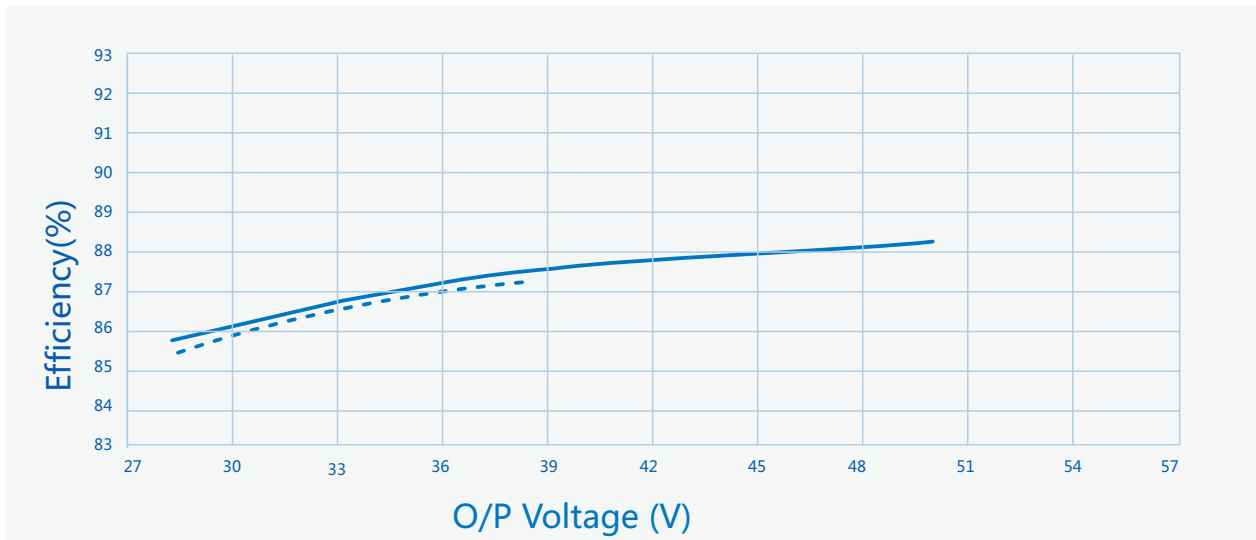

-----  $I_o=920mA$       —————  $I_o=700mA$

# SS-35VA-L50B LED Driver

## Performance Curves:

Power Factor Vs. O/P Power

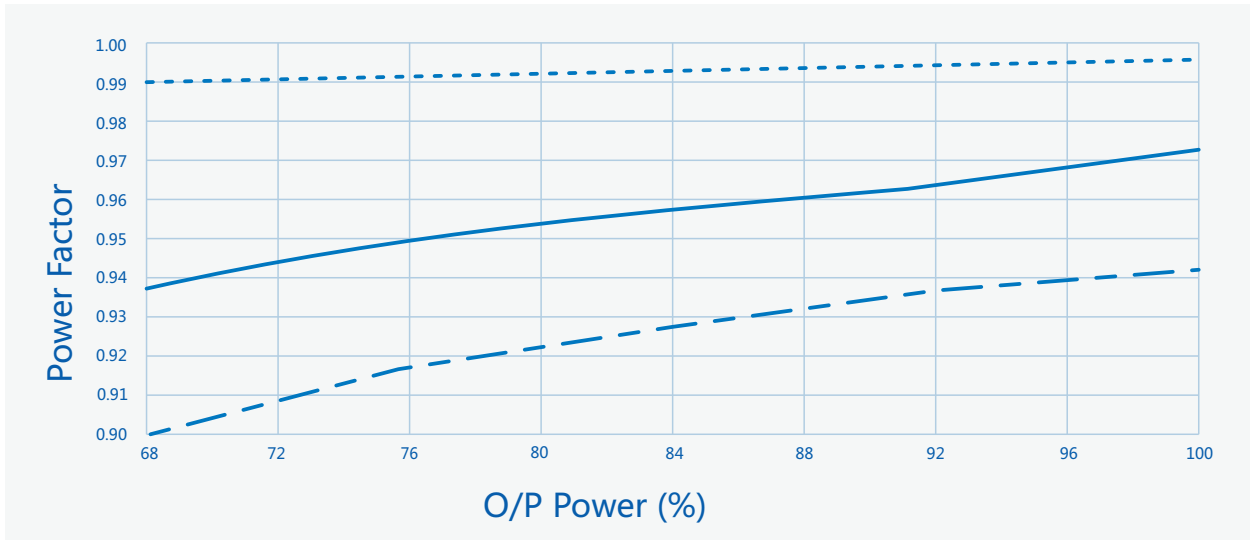

----- Vin=120Vac    ————— Vin=220Vac    - - - - Vin=277Vac

THD Vs. O/P Power

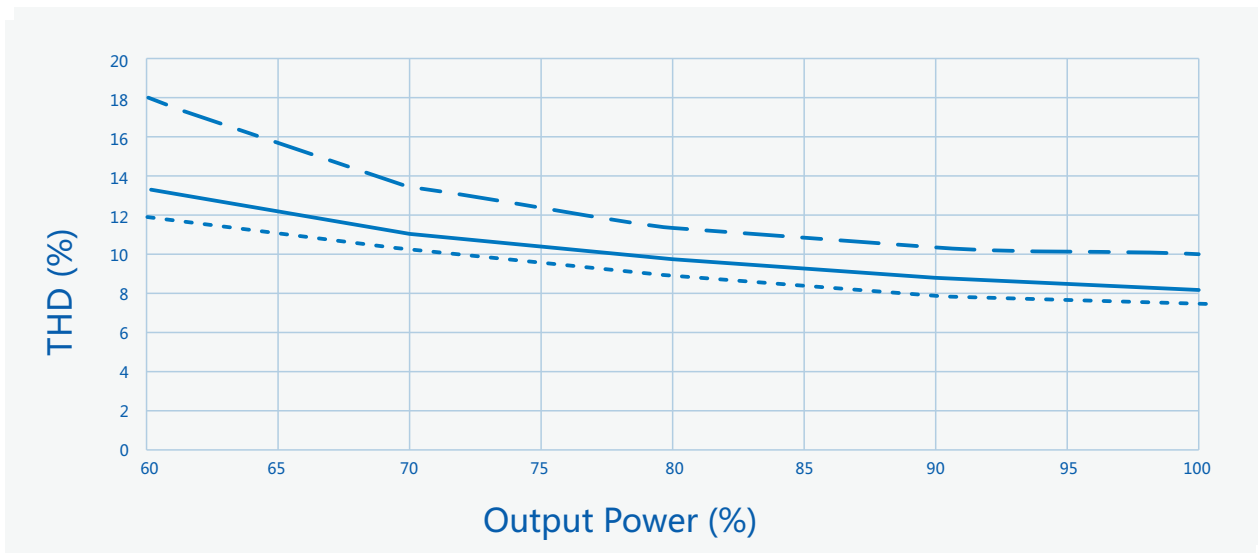

----- Vin=120Vac    ————— Vin=220Vac    - - - - Vin=277Vac

# SS-35VA-L50B LED Driver

## Performance Curves:

### O/P Power Vs. Input Voltage

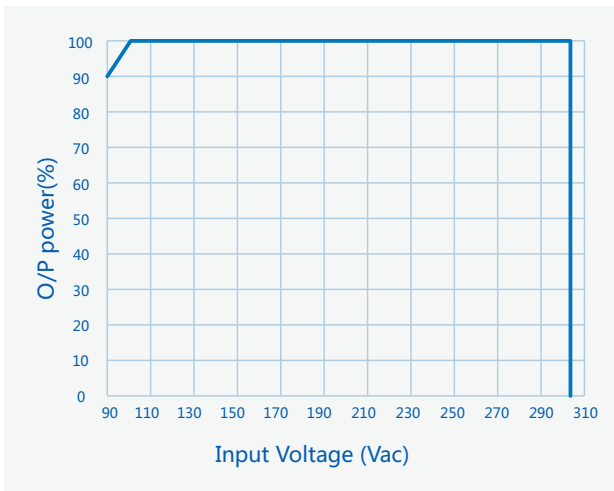

### Lifetime Vs. Case Temperature

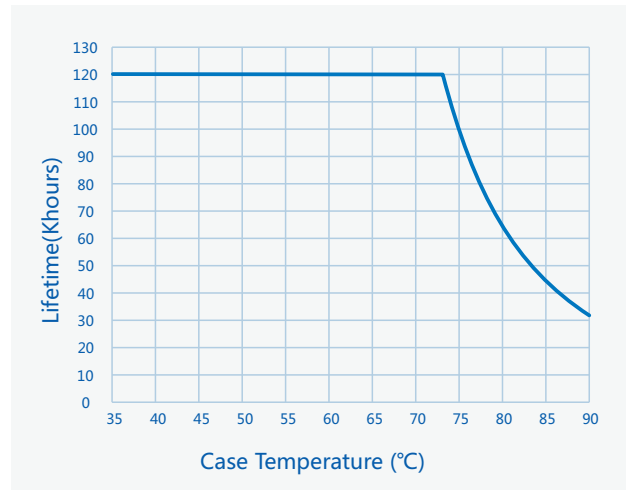

### O/P Power Vs. Dimming

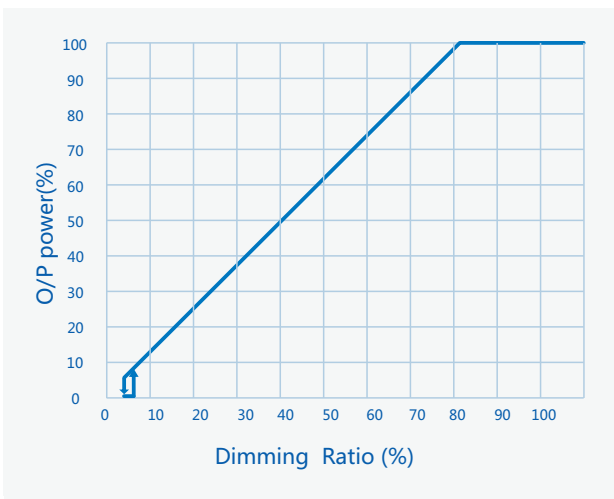

### O/P Power Vs. Dimming(5-0V)

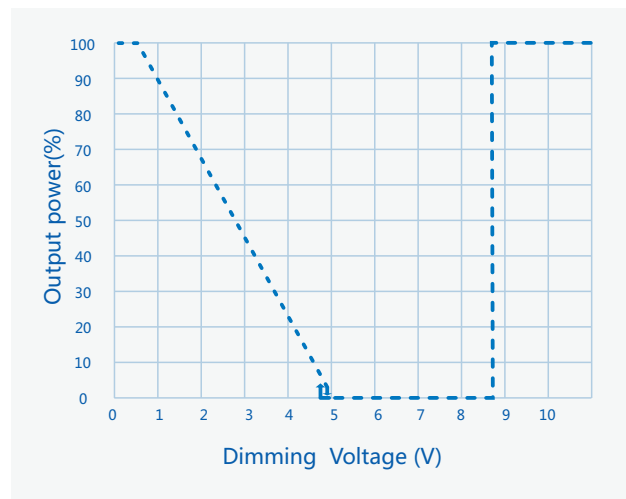

# SS-35VA-L50B LED Driver

## Mechanical Characteristics

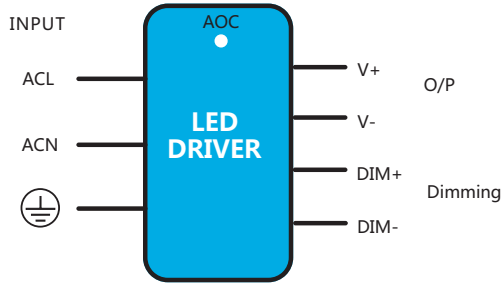

### AC Input Cable(Exposed Length 450±10mm):

Global model: SJOW,3\*17AWG,O.D: 8.0mm,Brown:L,Blue:N, Yellow/Green:  $\oplus$

### DC O/P Cable(Exposed Length 250±10mm):

UL model: UL 21996,2\*20AWG,O.D: 5.06mm,Red:V+ , Black:V-

### DIM/Timing Cable(Exposed Length 220±10mm):

UL model: UL 21996, 2\*22AWG , O.D: 4.7mm , Purple : DIM+, Pink: DIM-

Name Description	Standard Code	mm(In.)
Case Length	L3	107(4.21)
Case Width	W1	50(1.97)
Case Height	H	31(1.22)
Overall Length	L1	120(4.72)
Mounting Hole Length	L2	113.1(4.45)
Mounting Hole Width	W2	18.2(0.72)
TC Point Position	X	30(1.18)
TC Point Position	Y	18.5(0.73)

#### Note :

- 1,Please follow the "LED Driver User Manual" obtained from SOSEN's official website for assembly.
- 2,AC Input Cable,DC O/P Cable,DIM/AUX Power/Programming Cable: Peeled length of cable:43±5mm, Tinned length of wire:10±2mm

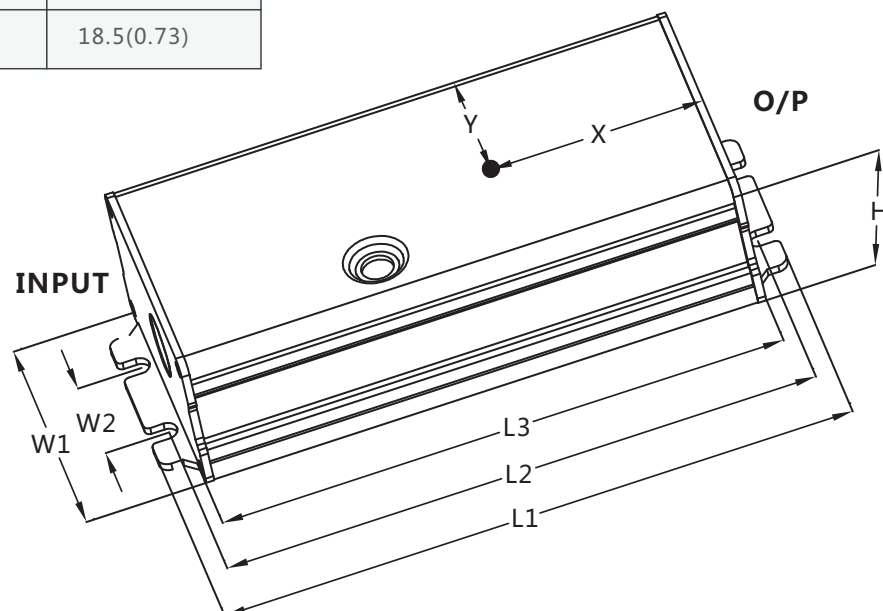

# SS-35VA-L50B LED Driver



## Assembly Tips

1. Highly recommended to seal the adjustable hole with silicon glue(#704 preferred) after adjusting the Driver's O/P current. Torsion with proper strength to avoid permanent damage to the potentiometer inside.
2. Dimming tinned connectors should be capped if not used to avoid dimming parts damage from external signals.

## Package

- Outside carton dimension: L×W×H =495mm×385mm×162mm;
- 42PCS/Carton;
- Net weight/Piece: 0.33kg;Gross weight/Carton: 16kg;
- Please refer to the product name, model number, manufacturer identification, QC PASS, manufacturing date on the package.

## Transportation

Packaging is designed suitable for transportation by trucks, vessels and flights. The products should be avoided direct sunlight and rain, loaded/unloaded with caution.

## Storage

The product storage meets the standard of the GB 3873 - 83.  
Products should be rechecked if stored for over 1 year before assembly.

## RoHS

Products comply with RoHS Directive (2011/65/EU) and amendment 2015/863/EU.

## Revision History

Version	Description of Update	Updated Date	Remark
V00	Original Release	2020/09/04	
V01	Increase Default Current	2020/10/13	
V02	Update Package Quantity	2020/12/28	
V03	Update DIM Cable Color	2021/09/02	
V04	Add Note About Dim To Off	2021/12/08	
V05	Add Page Number	2023/02/01	